

PyRe: A Cyclus Pyroprocessing Archetype

Greg Westphal
Advanced Reactors and Fuel Cycles Group

University of Illinois at Urbana-Champaign

November 12, 2018



I L L I N O I S



Outline

- 1 Introduction
- 2 Motivation
- 3 Methods
- 4 Results
- 5 Future Work

Introduction

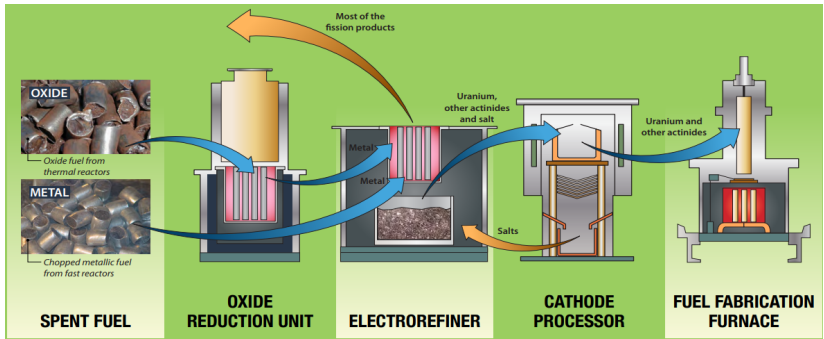

Figure 1: Argonne demonstration of a basic pyro plant [5].



Outline

- ① Introduction
- ② Motivation**
- ③ Methods
- ④ Results
- ⑤ Future Work



Motivation

Why model Pyroprocessing?

- Safeguard by design.
- Future fuel cycles.

What is the goal?

PyRe will be used to answer the following questions

- What is the effect of introducing pyroprocessing plants in the fuel cycle?
- How do various facility designs affect throughput and efficiency?
- Where in a pyroprocessing plant will monitoring most effectively detect material diversion?

The first two can be directly answered by the archetype. The third requires data analysis via diversion algorithms.



Cyclus

What is Cyclus?

Cyclus is a modular agent based fuel cycle simulator for tracking commodity transactions between facilities.

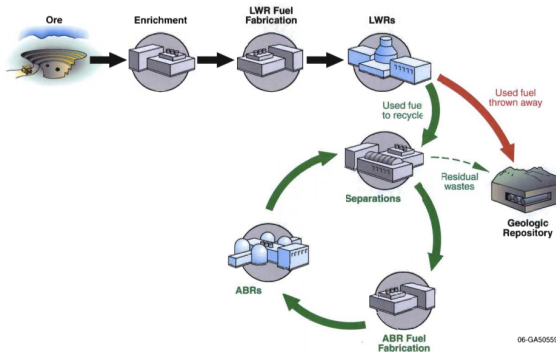

Figure 2: Example fuel cycle[6].



Why Cyclus?

Cyclus allows the construction of specific scenarios through the addition of archetypes. These archetypes are modular and the transactions can be tracked.

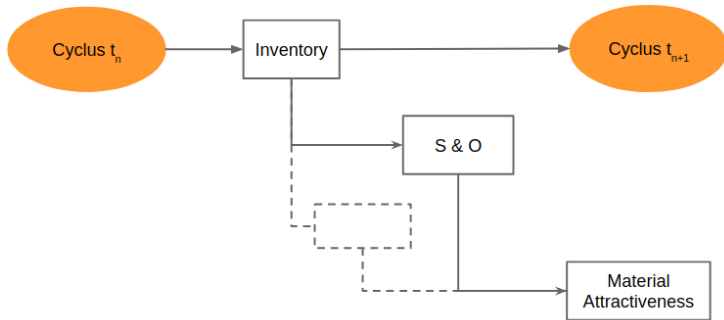

Figure 3: Diversion detection methods within Cyclus.



Outline

- ① Introduction
- ② Motivation
- ③ Methods**
- ④ Results
- ⑤ Future Work

Methodology



How does PyRe work?

PyRe does the following with an input stream and facility configuration parameters:

- Pass fuel to voloxidation.
- Generate efficiencies from parameters.
- Multiply stream by efficiency matrix.
- Record stream compositions.
- Repeat for each process.

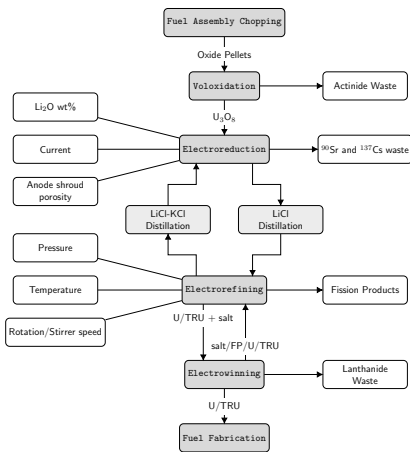

Figure 4: PyRe material flowchart [2].



NUCLEAR TECHNOLOGY · VOLUME 197 · 248–264 · MARCH 2017

© American Nuclear Society

DOI: <http://dx.doi.org/10.1080/00295450.2016.1273713>

Approaches to a Practical Systems Assessment for Safeguardability of Advanced Nuclear Fuel Cycles

R. A. Borrelli,^{a*} Joonhang Ahn,^b and Yongsoo Hwang^c

^aUniversity of Idaho, Nuclear Engineering Program, 995 University Boulevard, Idaho Falls, Idaho 83401

^bUniversity of California–Berkeley, Department of Nuclear Engineering, Berkeley, California 94720

^cKorea Institute of Nuclear Nonproliferation and Control, Center for Nuclear Strategy and Policy, Daejeon 305-348, Korea

Received August 16, 2016

Accepted for Publication November 29, 2016

Abstract — Many nations are expanding or initiating nuclear energy programs as part of a national energy portfolio. Transitioning to advanced nuclear energy systems improves sustainability and promotes energy independence. These advanced nuclear energy systems also must be shown to enhance safety, safeguards, and security in order to be realistically deployed. This is of particular concern to non-nuclear weapons states, to assure compliance with International Atomic Energy Agency treaty obligations.

Assumptions

Cyclus Requirements

- Modular.
- Time step ≥ 1 month
- Streams must be in a trade-able form.
- Parameters are constant for the simulation.
 - Equation input toolkit under development.
- Diversion detection must be added after.





Subprocesses - Voloxidation

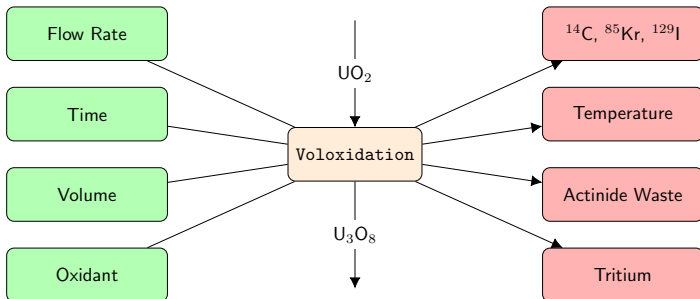

Figure 5: Voloxidation material balance area [3].



Subprocesses - Electroreduction

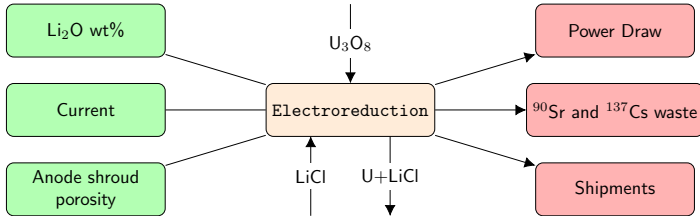

Figure 6: Reduction material balance area [4].



Subprocesses - Electrorefining

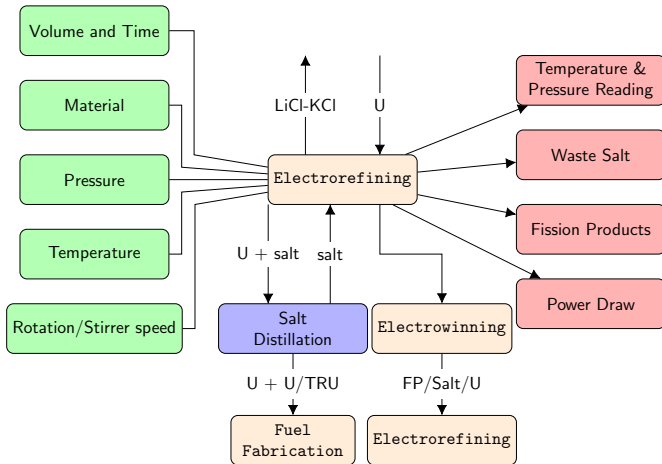

Figure 7: Refining material balance area [4].



Subprocesses - Electrowinning

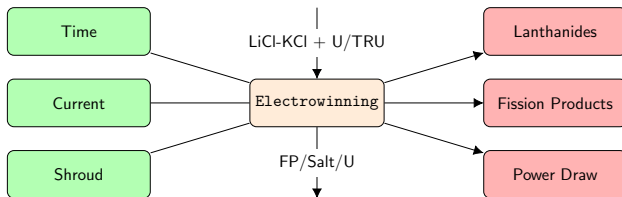

Figure 8: Winning material balance area.



Outline

- 1 Introduction
- 2 Motivation
- 3 Methods
- 4 Results**
- 5 Future Work



Average Sim

The first simulation is an example facility with the following input values:

- Temperature – 900 ° C
- Pressure – 500 mTorr
- Rotation – 100 rpm
- Current – 8 A
- Time – 1 hr

The simulation is run for 20 time steps with simple source and sink archetypes to facilitate trading.

This scenario was run to verify trading capabilities and general separations.



Average Sim - Results

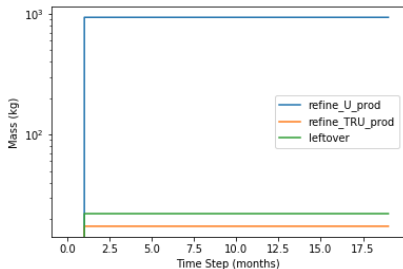

Figure 9: Product time series of a simple simulation.

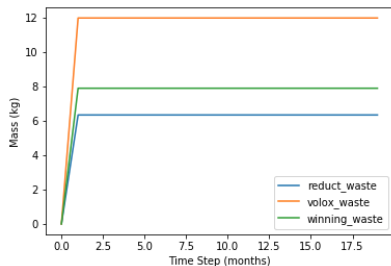

Figure 10: Waste time series of a simple simulation.



Isotopic Composition of Waste Streams

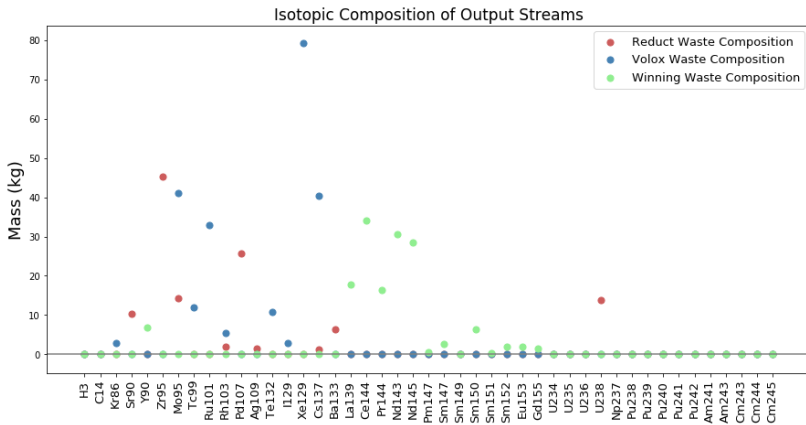

Figure 11: Isotopic Composition of Average Waste Streams



High Current Simulation

Secondly, a scenario was run with a current increase from 8 amps to 10 amps to observe potential diverted material.

- Temperature – 900 ° C
- Pressure – 500 mTorr
- Rotation – 100 rpm
- Current – 10 A
- Time – 1 hr

The simulation is run for 20 time steps with simple source and sink archetypes to facilitate trading.

We expect only Electroreduction and Electrowinning streams to change.

Current Diversion

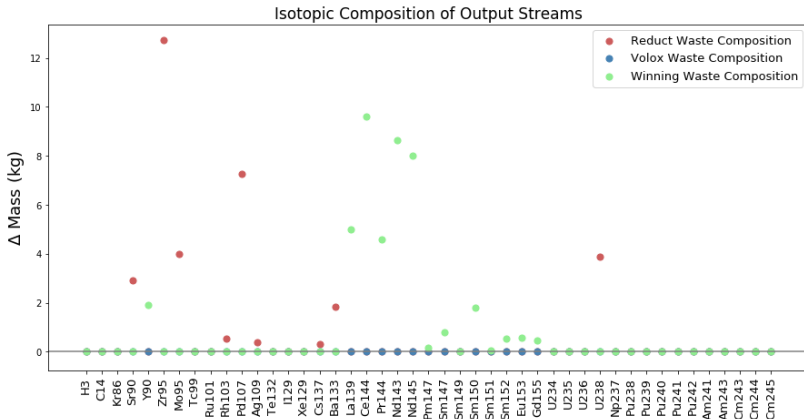

Figure 12: Isotopic Composition of Current Diverted Waste Streams



Max Diversion Scenario

Finally, a simulation was created to observe the maximum possible material discrepancy. This was done by running two separate simulations, one with each parameter at their maximum efficiency and the other at their minimums. The difference of these results will show how much of each material can be diverted.

- Temperature – 1000 °C vs. 500 °C
- Pressure – 120 mTorr vs. 760 mTorr
- Rotation – 100 rpm vs. 0 rpm
- Current – 10 A vs. 4 A
- Time – 4 hr vs. 1 hr

The simulation is run for 20 time steps with simple source and sink archetypes to facilitate trading.

Note: The values shown are cumulative over 20 transactions/months (Pu is of interest)

Isotopic Range

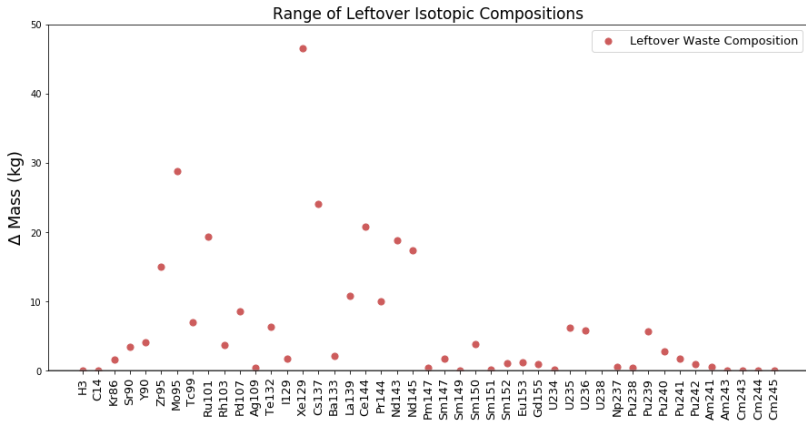

Figure 13: Range of Isotopic Values



Outline

- ① Introduction
- ② Motivation
- ③ Methods
- ④ Results
- ⑤ Future Work



Future Work

We have shown that PyRe allows Cyclus to simulate a simple pyroprocessing scenario. Future work includes:

- Increase scenario complexity - test shadow diversion
- Improve user input
 - Allow user-defined equations as input
- Chemistry first principles

Uses of PyRe:

In the beginning we marked the following objectives:

- What is the effect of introducing pyroprocessing plants in the fuel cycle?
- How do various facility designs affect throughput and efficiency?
- Where in a pyroprocessing plant will monitoring most effectively detect material diversion?



Diversion Algorithm

The first two questions can be answered through the addition of PyRe to Cyclus. However, to address the last we must employ an algorithm to analyze small differences between multiple simulations. The following are being considered to provide 'online' diversion detection:

- Cumulative Sum (CUSUM)
- Maximum likelihood

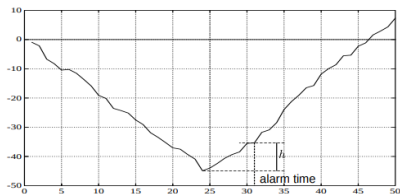

Figure 14: Example of a cumulative sum alarm [1].



Acknowledgement

This material is based upon work supported by the Department of Energy National Nuclear Security Administration under Award Number(s) DE-NA0002576 via the Consortium for Nonproliferation Enabling Capabilities.

Prof. Huff is supported by the Nuclear Regulatory Commission Faculty Development Program, the Blue Waters sustained-petascale computing project supported by the National Science Foundation (awards OCI-0725070 and ACI-1238993) and the state of Illinois, the NNSA Office of Defense Nuclear Nonproliferation R&D through the Consortium for Verification Technologies and the Consortium for Nonproliferation Enabling Capabilities (awards DE-NA0002576 and DE-NA0002534), and the International Institute for Carbon Neutral Energy Research (WPI-I2CNER), sponsored by the Japanese Ministry of Education, Culture, Sports, Science and Technology.



References I

- [1] Michele Basseville and Igor V. Nikiforov.
Detection of Abrupt Changes: Theory and Application.
Prentice Hall information and system sciences series. Prentice Hall, April 1993.
- [2] R. A. Borrelli, Joonhang Ahn, and Yongsoo Hwang.
Approaches to a Practical Systems Assessment for Safeguardability of Advanced Nuclear Fuel Cycles.
Nuclear Technology, 197(3):248–264, March 2017.
- [3] Robert Jubin.
Spent Fuel Reprocessing.
Technical report, Oak Ridge National Lab. (ORNL), Oak Ridge, TN (United States), 2009.
- [4] Hansoo Lee, Jong Hyun Lee, Sung Bin Park, Yoon Sang Lee, Eung Ho Kim, and Sung Won Park.
Advanced Electrorefining Process at KAERI.
ATALANTE 2008, May 2008.
- [5] Mark Williamson.
Pyroprocessing Technologies.
Technical report, Argonne National Laboratory (ANL).

References II



[6] Wenzhong Zhou.

Model and Simulation Code Development for Actinide-Containing Fuels, March 2011.